



Operating Instructions

Hydro Evaporation Water Baths

H 5 V, H 6 V, H 9 V, H 11 V, H 19 V



LAUDA Hydro Evaporation Water Bath models H 5 V are special Water Baths for gentle steaming work with different kinds of laboratory glasses. The Water Baths are equipped with a removable lid with a hole which is covered by a 9-part set of rings made of heat-resistant plastic material. The exterior housing is made of electrolytically galvanised sheet steel, powder-coated. All other constructive parts of the housing as well as the heating element are made of stainless steel.

LAUDA Hydro Evaporation Water Bath models H 6 V and H 9 V are special Water Baths for gentle evaporation work with different laboratory glass vessels. The openings in the fixed cover frame have a diameter of 131 mm and are covered by sets of rings made of heat-resistant plastic material. Behind each opening, a support rod of 600 mm length and 12 mm diameter can be screwed in for safe fixing of the evaporation vessels. The support rods are included in the scope of supply. The exterior housing is made of electrolytically galvanised and powder-coated sheet steel. All other constructive parts of the housing as well as the heating element are made of stainless steel.

LAUDA Hydro Evaporation Water Bath models H 11 V and H 19 V are special Water Baths for gentle steaming work with different kinds of laboratory glasses. These Water Baths were especially designed for protected use in fume hoods. All constructive parts of the housing as well as the heating element are made of stainless steel.

The temperature can be set between approx. 5 K above ambient and boiling point via an electro-mechanical temperature controller with capillary tube sensor, and are protected by a low water cut-off in case of dry running of the heating element. The heating element and the sensors of both temperature controller and low water cut-off are covered by a perforated floor to set up vessels.

Before installation, please check whether contents of package are in good order and complete. Should you note any damages or have any reasons for complaint, please contact your supplier or directly:

LAUDA DR. R. WOBSEER GMBH & CO. KG
Schulze-Delitzsch-Str. 4+5
30938 Burgwedel - Germany
Phone: +49 (0)5139 9958 0
Fax: +49 (0)5139 9958 21
Email: info@lauda.de
Internet: <https://www.lauda.de>

Translation of the original operating instructions
Q4DT-E_13-002-EN-01, 29.06.2023
© 2023 LAUDA DR. R. WOBSEER GMBH & CO. KG

Contents

Operating Instructions	1
1 Use of the Evaporation Water Bath	7
1.1 Intended Use.....	7
1.2 Improper Use	7
2 Warranty conditions.....	7
3 Before Installation / Initiation	8
4 Transport, Setup and Location of the Evaporation Water Baths.....	8
5 Operating Voltage.....	8
6 Filling Water into the Evaporation Water Bath	9
7 Adjustable Water Level Regulator (Accessory Order-No. A000024).....	9
8 Sets of Rings	9
9 Support Rods (H 6 V and H 9 V)	9
10 Starting Operation	10
11 Maintenance and Support	10
11.1 Technical support.....	11
11.2 Low water cut-off.....	11
12 Disposal of Old Appliances	12
13 Technical Data	13
13.1 Evaporation Water Bath Hydro H 5 V	13
13.2 Evaporation Water Baths Hydro H 6 V and H 9 V.....	14
13.3 Evaporation Water Baths Hydro H 11 V and H 19 V	15
14 Circuit Diagram.....	16
15 Examples for connection to the mains supply	17
15.1 Electrical fuses	17
15.2 Examples for connection to the mains	18
16 Accessories.....	19
17 Notes	20
18 Ordering spare parts / LAUDA Service	21
19 Product Returns and Clearance Declaration	22
20 EC Declaration of Conformity and certificates.....	23

1 Use of the Evaporation Water Bath

1.1 Intended Use

LAUDA Hydro Evaporation Water Baths are used with tap water for gentle steaming works with different kinds of laboratory glasses in a temperature range of approx. 5 K above ambient to boiling point.

The information contained in these operating instructions must by all means be read and observed. Only then can a perfect operation of the LAUDA Hydro Evaporation Water Bath be guaranteed. The units may only be installed and operated by persons who have made themselves familiar with these operating instructions.



Caution:

Hot surfaces at temperatures above 50 °C. Danger of burns, and danger of scaldings through steam released when opening the lid of the Evaporation Water Bath. It is recommended to wear suitable safety gloves.

1.2 Improper Use

Use the Evaporation Water Bath with tap water only. Other media, e. g. oils or acids, will lead to damages and, possibly, total unit failure. Neither aggressive nor corrosive waters may be used as a thermostating liquid. The Evaporation Water Bath may not be used in laboratory areas with aggressive or corrosive ambient conditions. It is not permissible to heat up or vaporise aggressive media, e. g. hydrochloric acid, in the unit itself or in its vicinity. The temperature work must not create an explosive atmosphere in the vicinity of the unit. The Evaporation Water Bath may not be operated in potentially explosive surroundings.

LAUDA Hydro Evaporation Water Baths are not suitable for direct temperature work of foodstuffs, beverages and tobacco or for medical-technical and pharmaceutical products. Direct temperature work means unprotected contact of the substances with the Evaporation Water Bath filling. LAUDA Hydro Evaporation Water Baths, operated in a laboratory, are no Medical Devices. They neither fall under national nor international Medical Device Directives nor have to be used and applied accordingly.

2 Warranty conditions

LAUDA offers a standard 12 month manufacturer's warranty from the date of purchase.

3 Before Installation / Initiation

The information given in the present manual must by all means be carefully read and observed. Only then can a perfect functioning of the Evaporation Water Bath be guaranteed. Safety precautions are additionally marked with the following symbols.



Read and observe the operating instructions



Warning of hot liquids and vapour



Warning of hot surfaces



Warning of dangerous electrical voltage



General warning

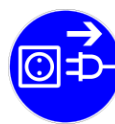

Before maintenance and repair disconnect the unit all-pole from the electrical mains (pull the plug from the socket).

4 Transport, Setup and Location of the Evaporation Water Baths



Place on solid, even and level surfaces inside buildings or in fume hoods only. Make sure to place the unit only on a water-tight, temperature-resistant and non-flammable surface. The unit is not suitable for use in potentially explosive surroundings. The Evaporation Water Baths H 5 V, H 6 V and H 9 V are not suitable for use in fume hoods when, at the same time, aggressive media, such as e. g. hydrochloric acid, are evaporated.

5 Operating Voltage



The main switch of the Evaporation Water Bath must be off (position O). The operating voltage on the nameplate (at the back of the unit) must be the same as the mains voltage. The Evaporation Water Bath must be connected to a correctly installed shock-proof socket. The bath is a protection class I electrical appliance, a connection to the earth conductor (PE) must be ensured. For information on the required mains fuse please view the technical data, chapter 10 of this manual. The electrical connection must ensure an all-pole separation from the mains supply at any time. The mains cable must not touch hot surfaces of the unit anywhere. It may not be led underneath the unit. In case of compliance, connect the unit to the mains.

6 Filling Water into the Evaporation Water Bath



Use the Evaporation Water Bath only with tap water. Even stainless steel will corrode when used improperly. Use neither ferruginous nor chlorous water, in order to prevent rust formation and pitting. Using distilled or deionised water will also ultimately lead to corrosion in the bath and must, therefore, be avoided.

Other media, such as oil, acid, or other additives, not approved by LAUDA, to prevent bacteria contamination (chlorine or copper sulphate), may lead to damages to the bath basin, the screw connections of the ducts and the heating element.

Before initiation, fill water into the Evaporation Water Bath. For maximum filling quantities please refer to the technical data, chapter 13 of these instructions. In case of overfilling water, the excess water quantity will flow off through the outlet of the adjustable water regulator (lower connection, see illustration below). Please use only tap water to operate the bath. Other media, such as oils or acids, may lead to damages to the bath basin, the screw connections of the ducts or the heating element.

7 Adjustable Water Level Regulator (Accessory Order-No. A000024)

The adjustable water regulator at the back of the Evaporation Water Bath serves to level out the loss of water due to evaporation during operation, thus maintaining the set water level. The upper hose connection of the water regulator is the water supply. Using a laboratory hose with an inner diameter of max 9 mm, connect this to the water mains. The lower hose connection is the overflow of the water regulator. Connect a laboratory hose (inner diameter of max 9 mm) and lead it into a drain on a lower level, ensuring free flow of the water without it being banked up.

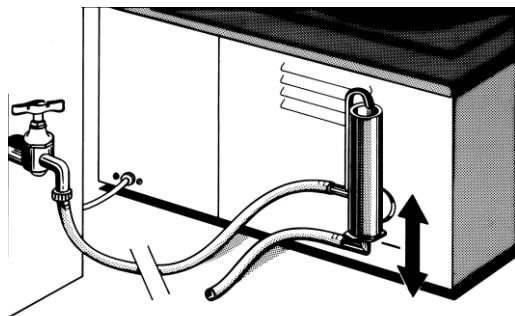

Secure all hose connections with hose clips. The required water level can be adjusted with the outlet tube of the water regulator. First loosen the the screw connection of the outlet tube, using a spanner GW 27. Set the required water level by pulling out or pushing in the tube in the regulator. Then tighten the screw connection again. Now open the tap of the mains supply very slightly to operate the Evaporation Water Bath.

8 Sets of Rings

The plastic sets of rings are used to cover all parts of the bath openings that are not required.

9 Support Rods (H 6 V and H 9 V)

By turning clockwise, the support rods, which are to be placed into the openings at the back of the bath rim, can be fastened.

10 Starting Operation

Switch on the main switch. The green pilot lamp in the main switch will light up. Set the required temperature on the control knob of the temperature regulator on the front of the unit. The temperature range of the bath is between approx. 5K above ambient and boiling point. For safe operation, especially at higher temperatures, it is important to cover all parts of the bath openings that are not required with the sets of rings.

Caution, please observe by all means.

To turn off for longer shut-down periods switch the main switch to position O and disconnect the unit from the mains. Empty the Evaporation Water Bath and dry the cabinet interior to prevent bacterial contamination.



Caution:

Hot surfaces at temperatures above 50 °C. Danger of burns and danger of scaldings through steam released when opening the Evaporation Water Bath. It is advisable to wear suitable safety gloves.

11 Maintenance and Support

The LAUDA Hydro Evaporation Water Bath is constructed to withstand even rough service conditions. Nevertheless, the unit should only be subjected to increased strain within sensible limits.

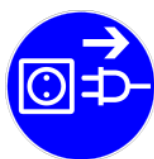

Make sure to prevent liquids coming into contact with cable connections or the inside of the electrical appliance.

Before opening and/or cleaning the unit, pull the plug from the socket.

Danger of electrical shock!



The perforated floor can be removed from the bath for cleaning procedures.

Caution, danger of scaldings! Do not reach into the hot water in the tank.

Lime deposits in the tank can be removed with commercial descaling agents (e. g. rea-calc® of M/s CHEMOTEC GmbH, 63486 Bruchköbel, Germany). Any descaling agent used must be admitted for use with stainless steel and must only be used according to the manufacturer's instructions. After descaling the boiler, rinse it several times with water in order to safely remove all remaining traces of the descaling agent. Never use products containing hydrochloric acid. These will damage the heating elements, the temperature sensors as well the tank and the screw connections of the ducts.

The stainless steel surfaces of the basin can be cleaned and its original shine be restored with commercial stainless steel polishing agents (e. g. "Helios Brillant" of M/s Ecolab Deutschland GmbH, 40789 Monheim, Germany). The powder-coated surfaces of the housing can be cleaned with mild, non-abrasive and pH neutral cleaning agents. Never use cleaning agents with solvents. It is advisable to change the water in the basin in regular intervals in order to prevent bacterial contamination. Should the Evaporation Water Bath have been contaminated with dangerous substances, cleaning and decontamination measures must be carried out according to the safety data sheets of these substances. It may be necessary afterwards to have the unit tested for function and safety by a trained electrician or by the service department in the manufacturing plant.

LAUDA Hydro Evaporation Water Baths are set and calibrated at a temperature of 50 °C. For re-calibration during servicing, an instruction to calibrate the temperature controller can be obtained from LAUDA. Please advise both model and serial number of the unit in such a case.

11.1 Technical support

You can call our customer service at any time for technical support relating to LAUDA Hydro Evaporation Water Baths Apparatus appliances.

Phone : +49 (0) 9343 / 503-350

Fax : +49 (0)9343 503-283

Email : service@lauda.de

Maintenance, repairs and modifications must be carried out by a qualified electrician (section 2 (3) DGUV Regulation 3) according to the General Rules of Technology (section 2 (2) DGUV Regulation 3). Only original spare parts may be used. Request that the person performing the work provides written confirmation of the type and scope of the work carried out (company, date, signature).

11.2 Low water cut-off

The Evaporation Water Bath's heating element is protected against running dry by a low water cut-off (thermostatic over-temperature limiter). In case of low water, power supply to the heating element is cut off. Before restarting the unit, the bath tank must cool down and then be filled with water, as described in chapter 5 – Filling Water into the Evaporation Water Bath, and the triggered low water cut-off must be released. To do so, unscrew the black cap nut. Within the thread, a white plastic pin will now be visible which must be gently pushed inside (e. g. with a pen) until a soft clicking sound can be heard. The efficiency of the low water cut-off can be checked by a temperature-controlled heat-up of the capillary tube sensor, e. g. with a hot air fan (after loosening the clamps from the heating element) exceeding the switch-off temperature of 135°C. The contact position of the fuse can be checked by a resistance measurement. If the fuse was triggered, the safety switch F1 will be open. This examination must be carried out by a trained electrician.

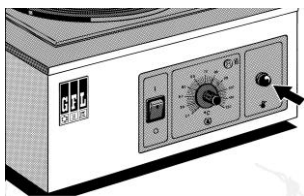

III.: H 5 V

12 Disposal of Old Appliances

LAUDA will take responsibility, within the scope of the legal directives, for an environmentally sound handling and disposal of all used LAUDA units as of the production year 1995 that are returned to us free of charge and will have them materially recycled. Before a unit is returned, a legally binding declaration must be provided from the sender confirming that the unit is free from harmful and/or hazardous contaminations as well as from hazardous substances caused by the previous use of the unit.

LAUDA laboratory apparatus are exclusively designed for industrial use and may not be disposed of through public waste disposal authorities.

EAR Registration Number WEEE-ID.NO 67770231

13 Technical Data

13.1 Evaporation Water Bath Hydro H 5 V

H 5 V	
Exterior dimensions (W x D x H)	342 mm x 400 mm x 180 mm
Interior dimensions (W x D x H)	240 mm x 240 mm x 120 mm
Number and diameter of openings in the bath cover	1 opening / 192 mm covered with 9-part set of rings, made of heat-resistant plastic material, with openings in a spacing of 32,5 mm, 52,5 mm, 72,5 mm, 92,5 mm, 112,5 mm, 132,5 mm, 153,5 mm and 173,5 mm
Maximum water level above perforated floor	75 mm
Maximum filling quantity to overflow of the adjustable water regulator	approx. 5 litres
Temperature range	approx. 5 K above ambient to boiling point
Temperature control	Electro-mechanical temperature regulator with capillary tube sensor
Temperature setting	Analogue, with control knob
Temperature constancy	approx. +/- 3 K
Over-temperature cut-out (low water cut-off)	Electro-mechanical temperature limiter with capillary tube sensor. Switch-off temperature 135 °C / -10 K
Electrical connection	230 V +/- 10 %, 50 / 60 Hz, 1,0 kW
Mains connection	Shock proof plug
Mains fuse	min. 10 A - max. 16 A
Protection type / Protection class	IP20 / I
Ambient conditions	Use only indoors (not in potentially explosive surroundings)
Height above sea level	up to 2000 m NN
Ambient temperature	+10 °C to +40 °C
Humidity	max. 80 % relative humidity to 31 °C, decreasing to 50 % relative humidity at 40 °C
Weight	9,0 kg

13.2 Evaporation Water Baths Hydro H 6 V and H 9 V

	H 6 V	H 9 V
Exterior Dimensions (W x D x H)	710 mm x 270 mm x 192 mm	1010 mm x 270 mm x 192 mm
Dim H without support rod		
Number and diameter of the bath's openings	4 openings / 131 mm covered with 4-part sets of rings, made of heat-resistant plastic material, with openings in a spacing of 32,5 mm, 52,5 mm and 72,5 mm	6 openings / 131 mm covered with 6-part sets of rings, made of heat-resistant plastic material, with openings in a spacing of 32,5 mm, 52,5 mm, 72,5 mm, 92,5 mm and 112,5 mm
Usable height (Perforated floor to upper rim of bath)	90 mm	90 mm
Maximum water level above perforated floor	50 mm	50 mm
Maximum filling quantity to overflow of adjustable water regulator	5,3 litres	8,0 litres
Temperature range	approx. 5 K above ambient to boiling point	approx. 5 K above ambient to boiling point
Temperature control	Electro-mechanical temperature regulator with capillary tube sensor	Electro-mechanical temperature regulator with capillary tube sensor
Temperature setting	Analogue, on the control knob	Analogue, on the control knob
Temporal temperature constancy	approx. +/- 3 K	approx. +/- 3 K
Over-temperature cut-out (low water cut-off)	Electro-mechanical temperature limiter with capillary tube sensor. Switch-off temperature 135 °C / -10K	Electro-mechanical temperature limiter with capillary tube sensor. Switch-off temperature 135 °C / -10K
Electrical connection	230 V +/- 10 %, 50 / 60 Hz, 1,0 kW	230 V +/- 10 %, 50 / 60 Hz, 1,5 kW
Mains connection	Shock proof plug	Shock proof plug
Mains fuse	min. 10 A - max. 16 A	min. 10 A - max. 16 A
Protection type / Protection class	IP20 / I	IP20 / I
Ambient conditions	Use only indoors (not in potentially explosive surroundings)	Use only indoors (not in potentially explosive surroundings)
Height above sea level	up to zu 2000 m NN	up to 2000 m NN
Ambient temperature	+10 °C to +40 °C	+10 °C to +40 °C
Humidity	max. 80 % relative humidity to 31 °C, decreasing to 50 % relative humidity at 40 °C	max. 80 % relative humidity to 31 °C, decreasing to 50 % relative humidity at 40 °C
Weight	12,4 kg	16,2 kg

13.3 Evaporation Water Baths Hydro H 11 V and H 19 V

	H 11 V	H 19 V
Exterior dimensions (W x D x H)	450 mm x 300 mm x 155 mm	690 mm x 300 mm x 155 mm
Number and diameter of the bath's openings	6 openings / 91 mm	8 openings / 111 mm
	covered with 4-part sets of rings, made of heat-resistant plastic material, with openings in a spacing of 32,5 mm, 52,5 mm and 72,5 mm	covered with 5-part sets of rings, made of heat-resistant plastic material, with openings in a spacing of 32,5 mm, 52,5 mm, 72,5 mm and 92,5 mm
Maximum water level above perforated floor	80 mm	80 mm
Maximum filling quantity To overflow of the adjustable water regulator	10,5 litres	18,4 litres
Temperature range	approx. 5 K above ambient to boiling point	approx. 5 K above ambient to boiling point
Temperature control	Electro-mechanical temperature regulator with capillary tube sensor	Electro-mechanical temperature regulator with capillary tube sensor
Temperature setting	Analogue, on the control knob	Analogue, on the control knob
Temperature constancy	ca. +/- 3 K	ca. +/- 3 K
Over-temperature cut-out (low water cut-off)	Electro-mechanical temperature limiter with capillary tube sensor Switch-off temperature 135 °C / -10 K	Electro-mechanical temperature limiter with capillary tube sensor Switch-off temperature 135 °C / -10 K
Electrical connection	230 V +/- 10 %, 50 / 60 Hz, 1,5 kW	230 V +/- 10 %, 50 / 60 Hz, 1,5 kW
Mains connection	Shock proof plug	Shock proof plug
Mains fuse	min. 10 A - max. 16 A	min. 10 A - max. 16 A
Protection type / protection class	IP20 / I	IP20 / I
Ambient conditions	Use only indoors (not in potentially explosive surroundings)	Use only indoors (not in potentially explosive surroundings)
Height above sea level	up to zu 2000 m NN	up to zu 2000 m NN
Ambient temperature	+10 °C to +40 °C	+10 °C to +40 °C
Humidity	max. 80 % relative humidity to 31 °C, decreasing to 50 % relative humidity at 40 °C	max. 80 % relative humidity to 31 °C, decreasing to 50 % relative humidity at 40 °C
Weight	5,8 kg	8,1 kg

14 Circuit Diagram

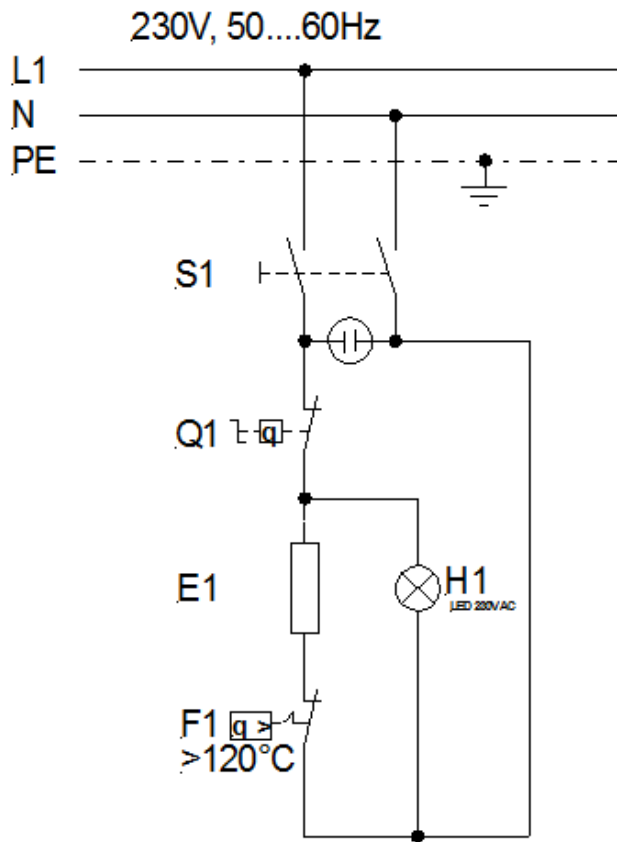

- E1 Heating element
- F1 Low water cut-off
- H1 Pilot lamp heating element
- Q1 Temperature regulator
- S1 Main switch

15 Examples for connection to the mains supply

Evaporation Water Baths models H 5 V to H 19 V are supplied with a pre-assembled, cast-on shock-proof plug. Make sure to connect to a protective conductor terminal.

Colour coding of mains cable	Mains supply
ge/gr – yellow/green	PE (Protective earth)
bl – blue	N
sw – black	L1

All Evaporation Water Baths supplied for 230 V (see information on the nameplate) can be connected to all power supplies of 220 V or 230 V. Maximum grid impedance $Z_{max} = 0,135 \Omega$. If necessary, this value should be requested from the responsible energy supply company.

15.1 Electrical fuses

Model	Power	Power consumption at mains voltage *	Mains fuse (F4, F5)
H 5 V, H 6 V	1,0 kW	4,4 A at 230 V	10 A / Amp (max. 16 A / Amp.)
H 9 V, H 11 V, H 19 V	1,5 kW	6,5 A at 230 V	10 A / Amp (max. 16 A / Amp.)

15.2 Examples for connection to the mains

Components

- B1 Earthing contact socket (on-site)
- B2 Earthing contact plug (mounted on the unit)
- F4 Mains fuse (on-site)
- F5 Mains fuse (on-site)

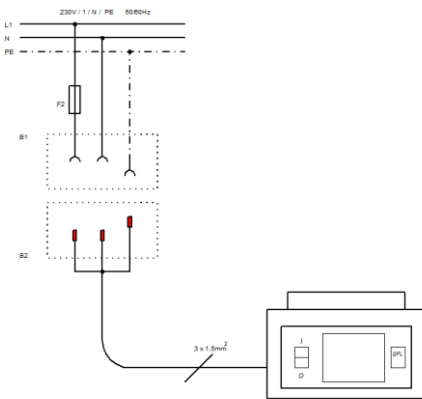

H 5 V, H 6 V, H 9 V, H 11 V, H 19 V
for 230 V with power supply 230 V / N / PE / 50/60 Hz,
connected through 3-pole shock-proof (Schuko) plug system.

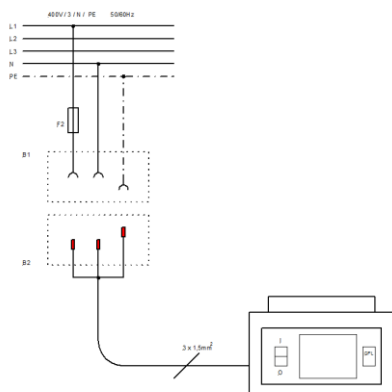

H 5 V, H 6 V, H 9 V, H 11 V, H 19 V
for 230 V with power supply 400 V / 3 / N / PE / 50/60 Hz,
connected through 3-pole shock-proof (Schuko) plug system.

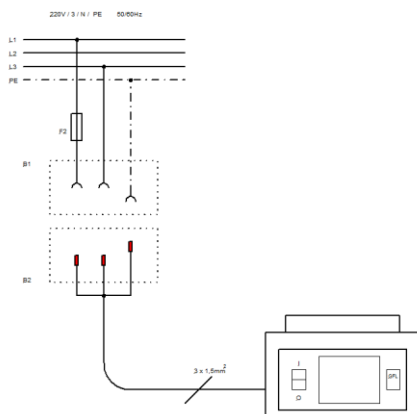

H 5 V, H 6 V, H 9 V, H 11 V, H 19 V
for 230 V with power supply 220 V / 3 / N / PE / 50/60 Hz,
connected through 3-pole shock-proof (Schuko) plug system.

16 Accessories



Support Rod, made of stainless steel, for safe fixing of steaming vessels. By turning clockwise, the support rod, which is to be placed into an opening at the back of the bath rim, can be fastened. Length 316 mm, \varnothing 12 mm.

Order no: A000039

18 Ordering spare parts / LAUDA Service

When ordering spare parts, please state the serial number (type plate) to avoid queries and wrong deliveries.

Your partner for maintenance and competent service support:

LAUDA Service
Phone: +49 (0)9343 503-350
Fax: +49 (0)9343 503-283
Email: service@lauda.de

We are always at your disposal for questions and suggestions!

LAUDA DR. R. WOBSER GMBH & CO. KG
Laudaplatz 1
97922 Lauda-Königshofen
Germany
Phone: +49 (0)9343 503-0
Fax: +49 (0)9343 503-222
Email info@lauda.de
Internet: <http://www.lauda.de/>

19 Product Returns and Clearance Declaration



Product Returns and Clearance Declaration

Product Returns

Would you like to return a LAUDA product you have purchased to LAUDA? For the return of goods, e.g. for repair or due to a complaint, you will need the approval of LAUDA in the form of a *Return Material Authorization (RMA)* or *processing number*. You can obtain the RMA number from our customer service department at +49 (0) 9343 503 350 or by email service@lauda.de.

Return address

LAUDA DR. R. WOBSE GMBH & CO. KG
Laudaplatz 1
97922 Lauda-Königshofen
Deutschland/Germany

Clearly label your shipment with the RMA number. Please also enclose this fully completed declaration.

RMA number	Product serial number
Customer/operator	Contact name
Contact email	Contact telephone
Zip code	Place
Street & house number	
Additional explanations	

Clearance Declaration

The customer/operator hereby confirms that the product returned under the above-mentioned RMA number has been carefully emptied and cleaned, that any connections have been sealed to the farthest possible extent, and that there are no explosive, flammable, environmentally hazardous, biohazardous, toxic, radioactive or other hazardous substances in or on the product.

Place, date	Name in block letters	Signature



EC DECLARATION OF CONFORMITY

Manufacturer: LAUDA DR. R. WOBSEY GMBH & CO. KG
Schulze-Delitzsch-Straße 4+5, 30938 Burgwedel, Germany

We hereby declare under our sole responsibility that the machines described below

Product Line: Hydro **Serial number:** from 220_____

Types: H 4, H 8, H 8 A, H 16, H 16 A, H 22, H 24 and H 41
H 20 S, H 20 SW and H 20 SOW
H 5 V, H 6 V, H 9 V, H 11 V and H 19 V
H 2 P

comply with all relevant provisions of the EC Directives listed below due to their design and type of construction in the version brought on the market by us:

Machinery Directive	2006/42/EC
EMC Directive	2014/30/EU
RoHS Directive	2011/65/EU in connection with (EU) 2015/863

The protective objectives of the Machinery Directive with regard to electrical safety are complied with in accordance with Annex I Paragraph 1.5.1 in conformity with the Low Voltage Directive 2014/35/EU.

Applied standards:

- EN 61326-1:2013
- EN 61010-1:2010/A1:2019/AC:2019-04
- EN IEC 61010-2-010:2020

Authorized representative for the composition of the technical documentation:

Dr. Jürgen Dirscherl, Head of Research & Development

Burgwedel, 05.06.2023



Dr. Alexander Dinger,
Head of Quality and Environmental Management

LAUDA DR. R. WOBSE GMBH & CO. KG

Schulze-Delitzsch-Straße 4+5 • 30938 Burgwedel • Germany

Phone.: +49 (0) 5139 9958-0 • Fax +49 (0) 5139 9958-21

Email: info@lauda.de • Internet: <https://www.lauda.de>